

No.	品名 Part	材質 Material	仕様 Method
1	株 Socket	C3604	
2	ケース Case	SPCC	Black
3	カバー Cover	SPCC	Black
4	針 Pointer	Aluminium	Black
	目盛板 Dial plate	Aluminium	White
	ブルドン管 Bourdon tube	C3604	
	内機 Movement	C5212	
	透明板 Transparent plate	Glass	

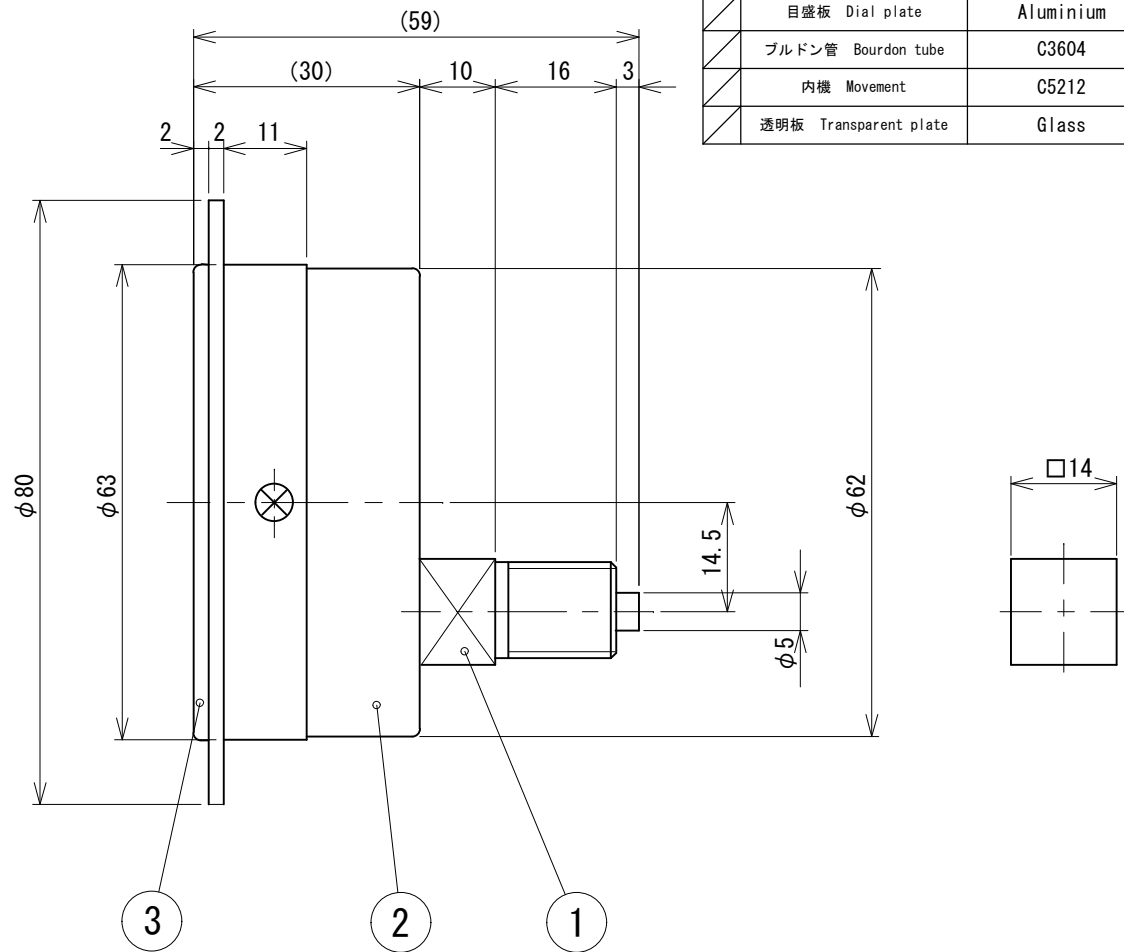
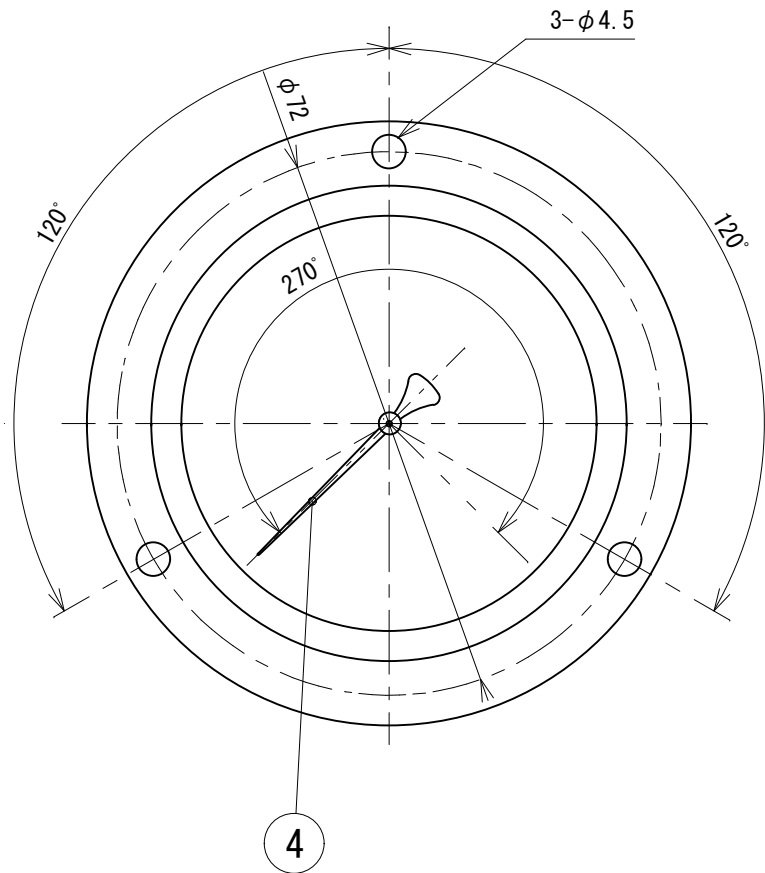

承認 Approval Kumazawa	点検 Inspect Kimura	作成 Drawn Sakamoto	名称 Title D 1/4R 60φ 圧力計 Pressure gauge
		尺度 Scale 1:1	
 ソーサープランニング株式会社 Socer-planning Co., LTD		作成日 Draw up 2018, 2, 1	図番 DWG No. D-NPG-60