

No.	品名 Part	材質 Material	仕様 Method
1	針 Pointer	A-5082P	Black
2	目盛板 Dial plate	SPCC	Black letter
3	リング Ring	ABS	Black
4	ケース Case	ABS	Black
5	廻りネジ Swivel nut	C3604BD	Nickel plating
6	取付ネジ Connector	C3604BD	Nickel plating
7	感温部 Stem	C1220T	Nickel plating
8	保護管 Thermowell	C1220T	Nickel plating

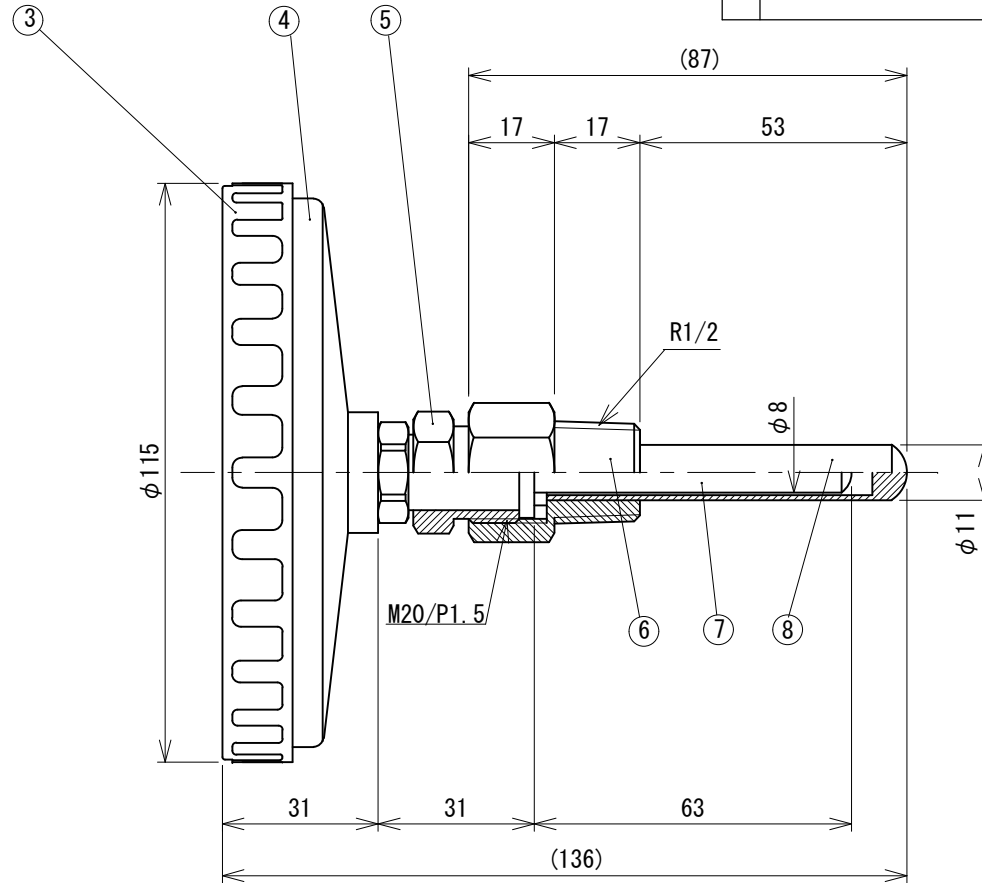
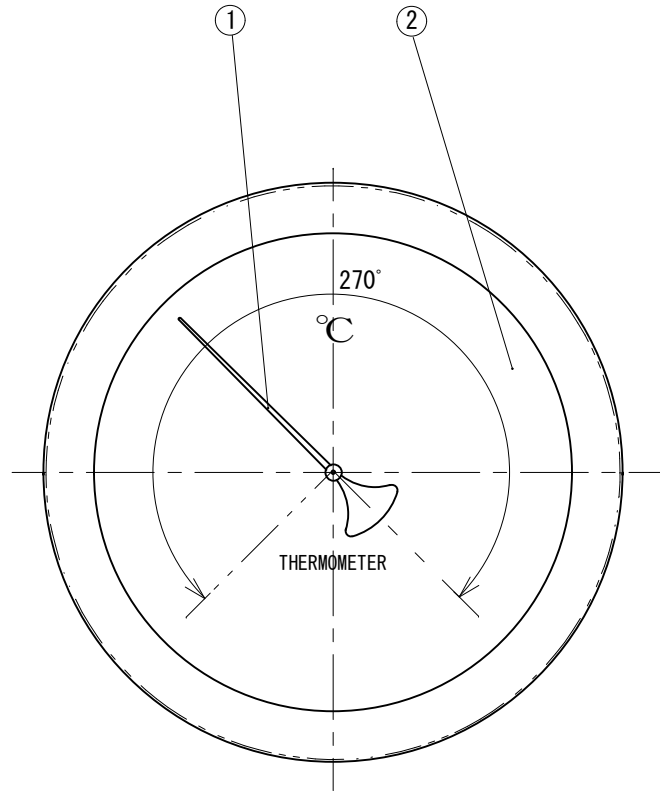

承認 Approval <i>Kumazawa</i>	点検 Inspect <i>Kimura</i>	作成 Drawn <i>Sakamoto</i>	名称 Title TW1/2R100φBS保護管付 50mm バイメタル温度計 Bimetal thermometer
		尺度 Scale 1:1.5	作成日 Draw up 2018. 2. 1
		ソーサープランニング株式会社 <i>Socer-planning Co., LTD</i>	図番 DWG No. T-NBTG-50-BS